

[www.okw.com](http://www.okw.com)



# TUNING KNOBS

AWARD-WINNING TUNING, CONTROL AND  
COLLET KNOBS IN ERGONOMIC,  
MODERN AND CLASSIC DESIGNS

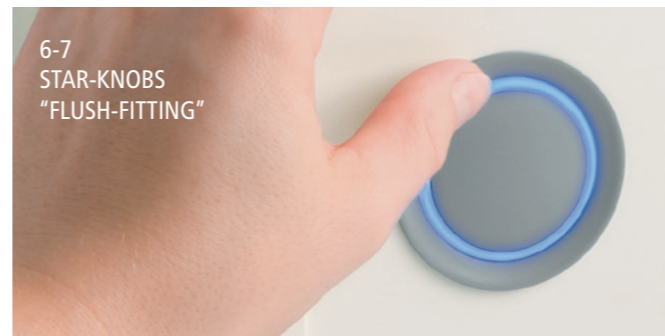
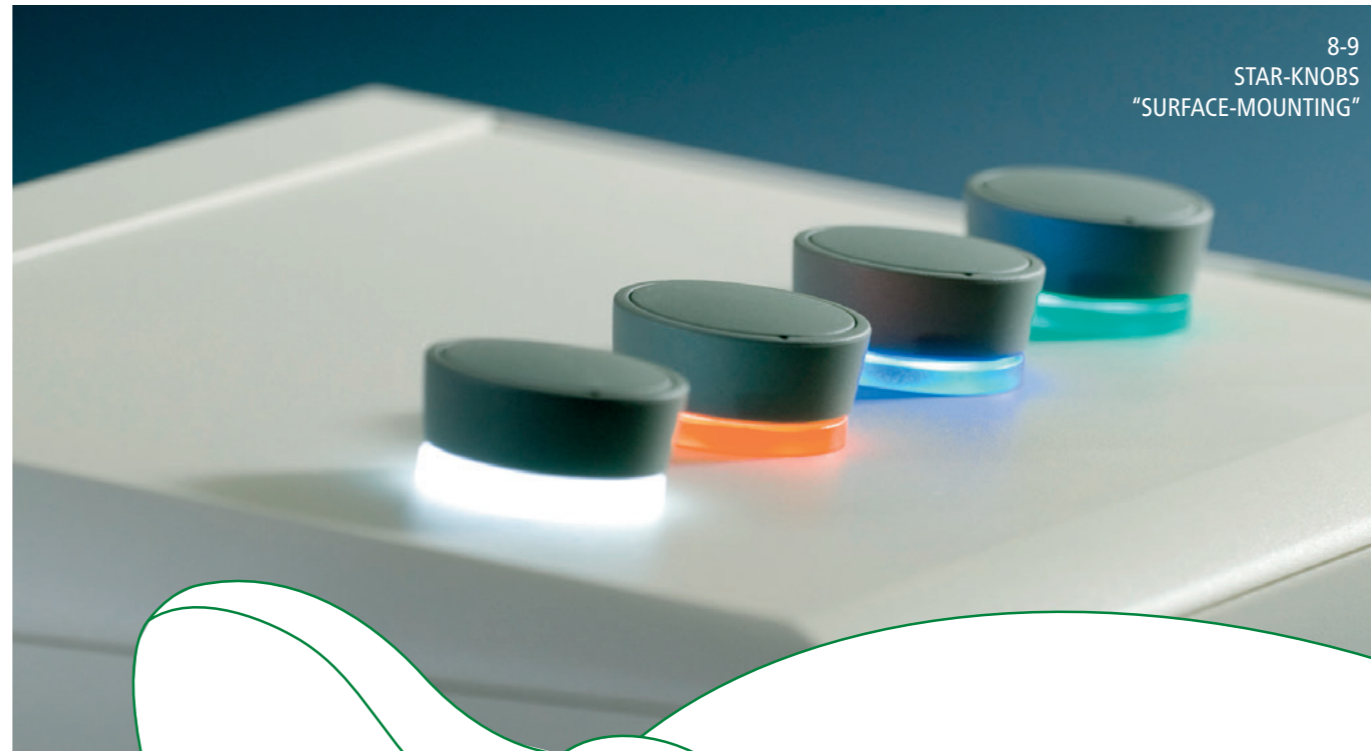

**OKW**  
GEHÄUSE  
SYSTEME

4-5  
CONTROL-KNOBS6-7  
STAR-KNOBS  
"FLUSH-FITTING"8-9  
STAR-KNOBS  
"SURFACE-MOUNTING"10-11  
COM-KNOBS12-13  
TOP-KNOBS14-15  
COMBINATION KNOBS16  
TUNING KNOBS „CLASSIC“36-37  
CUSTOMISING TUNING-KNOBS39  
PROPERTIES OF MATERIAL  
AS WELL AS RECOMMENDED USE

# POTENTIOMETER / TUNING KNOBS

OKW has over 70 years' experience in the development and production of potentiometer knobs. Today we can offer a wide range of modern and traditional tuning knob designs for spindles from 3 to 8 mm.

Our latest operating elements combine special technical features with a contemporary appearance. This includes optional LED illumination, flush-fitting installation, a main body which is slightly inclined towards the internal axis, function-oriented marking elements, modern colour selection etc.

The OKW range of tuning knobs is well tried and tested for rotary potentiometers with round and flattened shaft ends in accordance with DIN 41591 or 6/4.6 mm. The knobs are fitted using the proven collet fixture, lateral screw fixing or simply by pushing them on. Choose from round knobs, wing knobs, spindle-shaped knobs, pointer knobs or simple rotary switches. Different sizes and combinations offer a wide range of possible solutions.

NEW

**MATERIAL / COLOUR**

Soft-touch TPE outer shell

- TPE, volcano
- TPE, nero

Knob body

- PC, translucent (can be illuminated)
- PC, traffic white RAL 9016 (for applications without illumination)

Cover / Base

- PA 6, vulcano
- PA 6, nero

**KNOB SIZES (MM)**

ø 36 mm  
(boreholes 6 mm and 1/4")

ø 46 mm  
(boreholes 6 mm and 1/4")

**BACKLIGHT**

Optional illumination possible with modern, energy-saving SMD LED technology.

RGB

RGB backlight for individual colours. You can display your own colour.

**FASTENING**

Tried and tested collet fixture system with secure fit on the axle according to DIN 41591. Max. tightening torque: assembly = 1.5 Nm, function = 1.2 Nm.

**CUSTOMISING**

- Machining\*
  - Printing\*
  - Laser marking\*
  - Installation/Assembly of accessories
- \*cover only

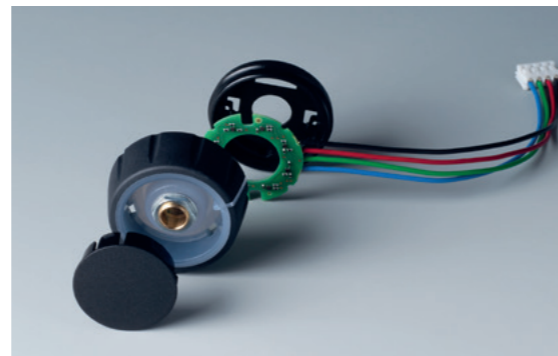
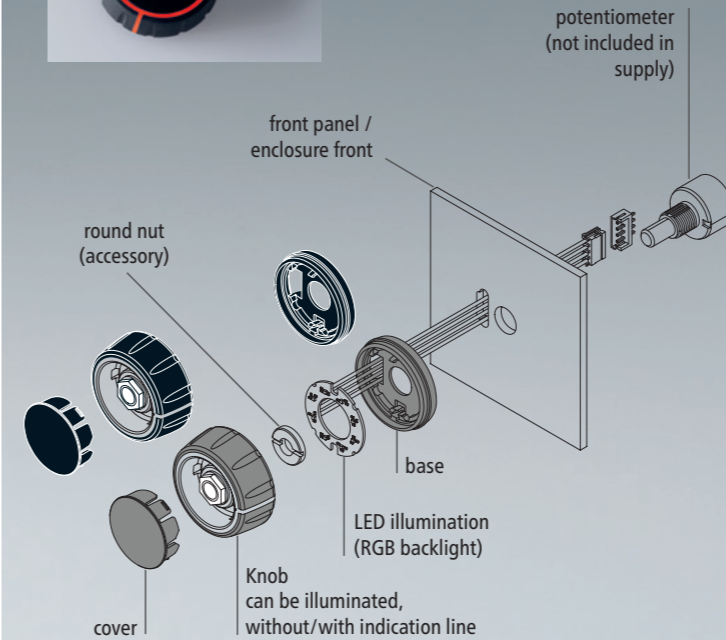
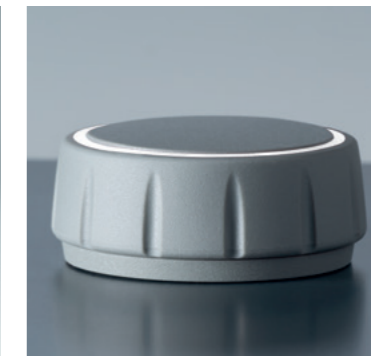
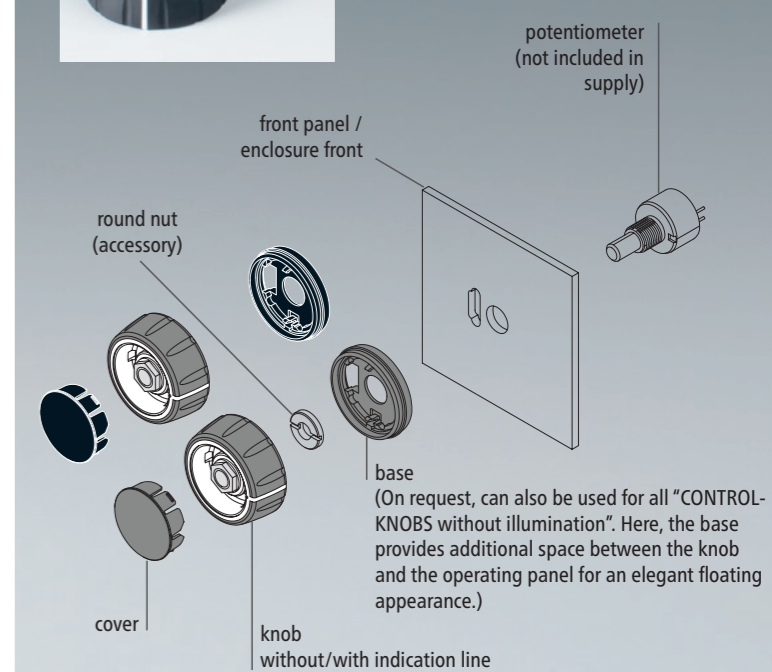
**CONTROL-KNOBS WITH ILLUMINATION****CONTROL-KNOBS WITHOUT ILLUMINATION**

Order data on pages 18-19

# CONTROL-KNOBS

**POTENTIOMETER TUNING KNOBS THAT ARE HIGHLY COMFORTABLE TO OPERATE**

New ergonomic CONTROL-KNOBS have a soft-touch surface which is easy to grip and feels comfortable in operation.

The high-quality appearance – illuminated if required – distinguishes this advanced range of tuning knobs as the central element of menu-driven interfaces.

Designed as modern control knobs for rotary potentiometers or encoders; also suitable for rotary touch/click functions used on menu-driven interfaces – typically employed on devices made in high volumes.

**YOUR ADVANTAGE**

- soft-touch surface ensures good grip and anti-slip operation
- innovative two-part plastic tuning knob design comprises a hard inner knob body made of high-quality PC and a soft-touch TPE outer shell with functional grooved appearance  
\*\*\* iF product design award 2022 \*\*\*
- available in two knob sizes, ø 36 mm and ø 46 mm, each in two standard TPE colours (nero and volcano)
- 16 different versions each size
- with/without pointer line on the side for fine scaling

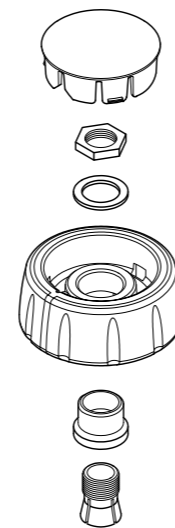
**YOUR ADVANTAGE**

- with/without optional LED illumination
- illumination options:
  - translucent optic ring on the top surface
  - translucent optic ring on the top surface with a pointer line on the side

(note: order the CONTROL-KNOBS with optional illumination, plus the base and the LED illumination kit, see accessories)
- optional illumination uses modern, energy-saving SMD LED technology for 5 V power supply units (RGB LEDs allow individual illumination and colours)

**APPLICATION FIELDS**

For rotary potentiometers or rotary pulse generators with round shaft ends in accordance with DIN 41591, including touch function:

- Measuring and control technology
- Health Care
- Heating and air conditioning
- Communication devices
- Building management
- Smart Factory

**MATERIAL / COLOUR****Knob**

- PA, volcano
- PA, nero
- PC, diamond (can be illuminated)
- PC, emerald (can be illuminated)
- PC, sapphire (can be illuminated)

**Cover**

- PA, volcano
- PA, nero

**FASTENING**

Tried and tested collet fixture system with secure fit on the axle.

**KNOB SIZES (MM)**

- ø 33 mm  
(boreholes 6 mm, 1/4")
- ø 41 mm  
(boreholes 6 mm)

**BACKLIGHT**

Optional illumination possible with modern, energy-saving SMD LED technology.

With white backlight you can realize the colours diamond, ruby, emerald and sapphire.

**RGB**

For individual colours there is a RGB backlight available. In this way you can display your own colour.

**CUSTOMISING**

- Machining
- Printing / Laser marking
- Lacquering (only on request and according to sample)
- Installation / Assembly of acc.

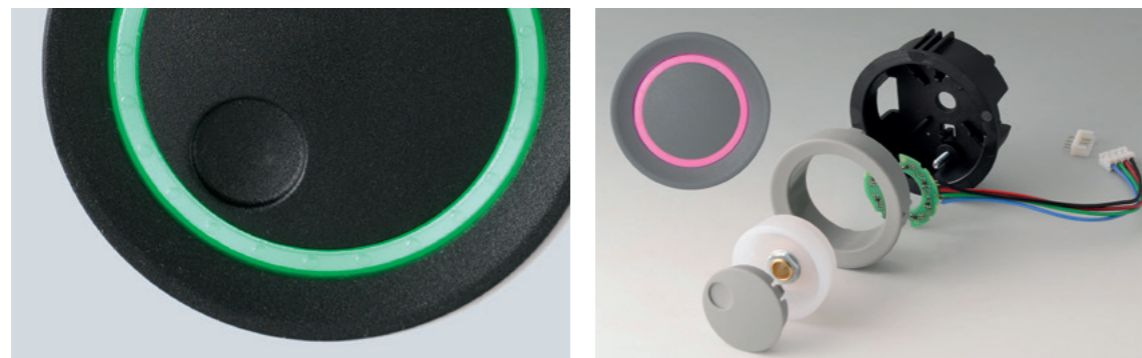

## STAR-KNOBS "FLUSH-FITTING"

**MODERN ILLUMINATED TUNING KNOBS**

Our STAR-KNOBS are designed for menu driven interfaces, click rotation and click push-in for 'OK'. This reduces the number of knobs and controls required on the front panel. The illumination is a visual highlight and enhances user operation of the equipment.

**INNOVATIVE DESIGN FOR FLUSH FITTING OR SURFACE MOUNTING****YOUR ADVANTAGE**

- the flush-fitting version represents an attractive transition between the knob and the front of the device; the knob can be illuminated, that is, a ring lights up between the recess and the knob cover
- knob with or without knurls
- cover with or without finger recess for fine adjustments
- tried and tested collet fixture system with secure fit on the axle
- max. torques: assembly = 1.5 Nm, function = 1.2 Nm
- minimum components for 1 STAR-KNOB:  
1 knob, 1 cover, 1 assembly kit

## STAR-KNOBS "FLUSH-FITTING"

**APPLICATION FIELDS**

For rotary potentiometers or rotary pulse generators with round shaft ends in accordance with DIN 41591, including touch function:

- Measuring and control technology
- Health Care
- Heating and air conditioning
- Communication devices
- Building management
- Smart Factory

**ILLUMINATION**

Illumination possible with modern, energy-saving SMD LED technology for power supply units with 5 V: either white backlight for the colours diamond, ruby, emerald and sapphire or RGB backlight for individual colours as accessory.

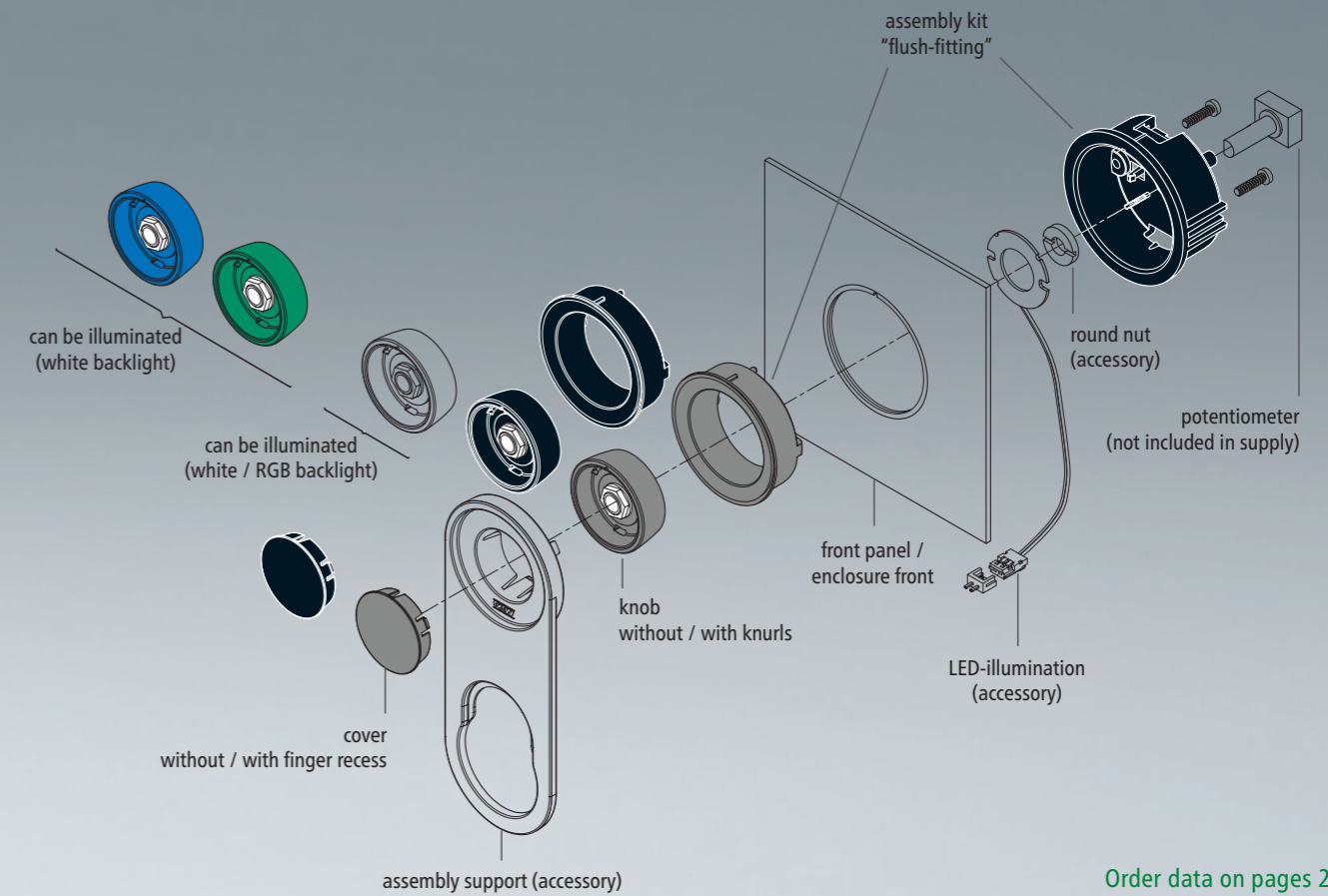

Order data on pages 20-21

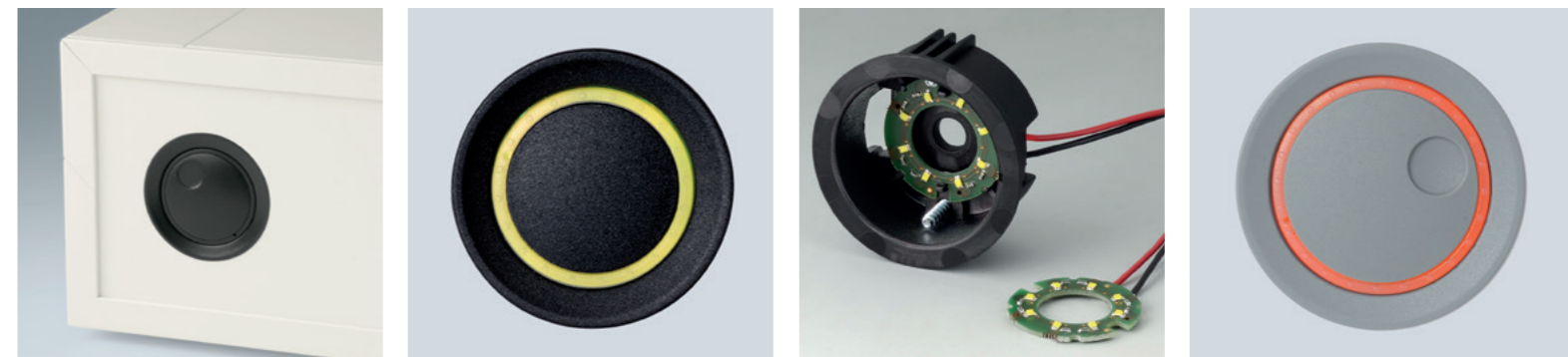

**MATERIAL / COLOUR**

Knob, cover

● PA, volcano

● PA, nero

Ring (can be illuminated)

● PC, diamond

● PC, sapphire

**KNOB SIZES (MM)**ø 33 mm  
(boreholes 6 mm, 1/4")ø 41 mm  
(boreholes 6 mm)**BACKLIGHT**

Optional illumination possible with modern, energy-saving SMD LED technology.

With white backlight you can realize the colours diamond, ruby, emerald and sapphire.

**RGB**

For individual colours there is a RGB backlight available. In this way you can display your own colour.

**FASTENING**

Tried and tested collet fixture system with secure fit on the axle.

**CUSTOMISING**

- Machining
- Printing
- Laser marking
- Lacquering (only on request and according to sample)
- Installation / Assembly of acc.



## STAR-KNOBS "SURFACE-MOUNTED"

**MODERN ILLUMINATED TUNING KNOBS**

Our STAR-KNOBS are designed for menu driven interfaces, click rotation and click push-in for 'OK'. This reduces the number of knobs and controls required on the front panel. The illumination is a visual highlight and enhances user operation of the equipment.

**INNOVATIVE DESIGN FOR FLUSH FITTING OR SURFACE MOUNTING****YOUR ADVANTAGE**

- with the surface-mounted version, the knob design makes a great impression thanks to the slight inclination of the body towards the inner axis, thus allowing ergonomically comfortable operation; the knob is mounted on an approx. 3 mm high ring, which can be illuminated if required
- knob with or without knurls
- cover with or without finger recess for fine adjustments
- tried and tested collet fixture system with secure fit on the axle
- max. torques: assembly = 1.5 Nm, function = 1.2 Nm
- minimum components for 1 STAR-KNOB:  
1 knob, 1 cover, 1 assembly kit

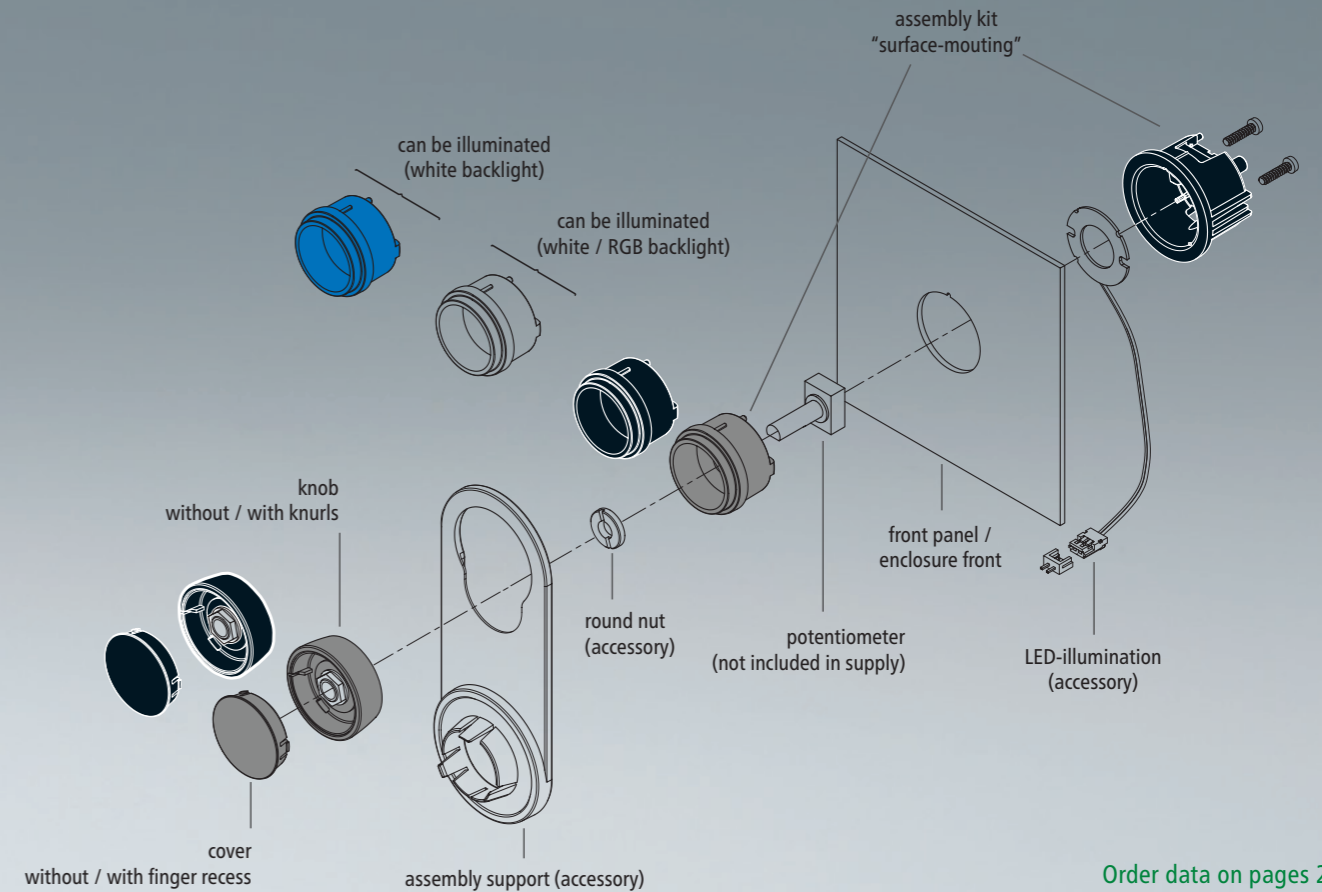

Order data on pages 20-21



## STAR-KNOBS "SURFACE-MOUNTED"

**APPLICATION FIELDS**

For rotary potentiometers or rotary pulse generators with round shaft ends in accordance with DIN 41591, including touch function:

- Measuring and control technology
- Health Care
- Heating and air conditioning
- Communication devices
- Building management
- Smart Factory

**ILLUMINATION**

Illumination possible with modern, energy-saving SMD LED technology for power supply units with 5 V: either white backlight for the colours diamond, ruby, emerald and sapphire or RGB backlight for individual colours as accessory.

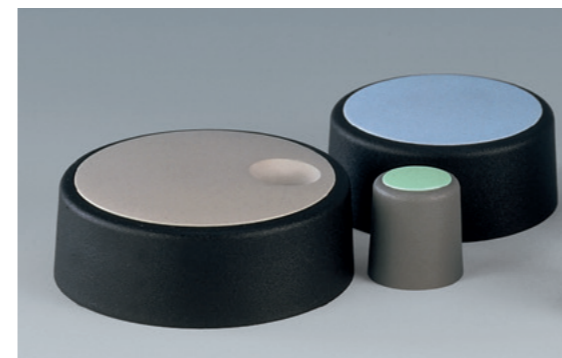
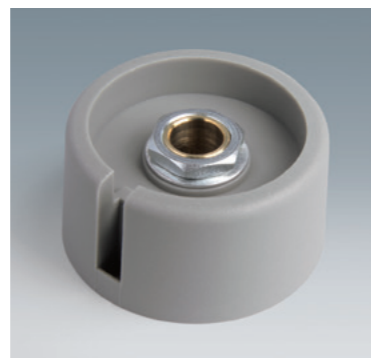
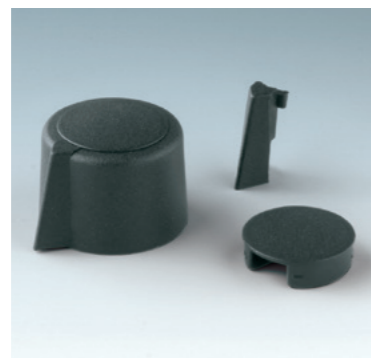

**MATERIAL / COLOUR**

- Knob  
 ● PA 6, volcano  
 ● PA 6, nero

- Cover / marking elements  
 ● PA 6, coral  
 ● PA 6, beach  
 ● PA 6, lagoon  
 ● PA 6, sky  
 ● PA 6, mineral  
 ● PA 6, nero



- Cover  
 "Metallic look"  
 ● ABS (UL 94 HB), matt chromed  
 (only available for sizes ø 23-40)

**KNOB SIZES (MM)**

ø 16 mm / ø 20 mm / ø 23 mm  
 (boreholes 4 mm / 6 mm / 1/4")

ø 31 mm  
 (boreholes 6 mm and 1/4")

ø 40 mm / ø 50 mm  
 (boreholes 6 mm and 8 mm)

**FASTENING**

With collet fixture system for rotary potentiometer with shaft ends according to DIN 41591.

**CUSTOMISING**

- Machining
  - Printing
  - Laser marking
  - Lacquering
  - Installation / Assembly of acc.
- See pages 36-37.

Order data on pages 24-25

# COM-KNOBS

**MODERN COLLET KNOB SYSTEM**

Aesthetic design, a modern selection of pastel colours, and a secure collet fixing system are the main features of our COM-KNOBS range. These very attractive tuning knobs will give your application a high-quality appearance.

**YOUR ADVANTAGE**

- modern and innovative control knobs
- cover with a matt chrome finish for a classy metallic look (sizes 23-40)
- reliable operation with the tried and tested collet fixing system
- convenient assembly from the front with tight fitting on the axis
- with/without slot for arrow marking elements

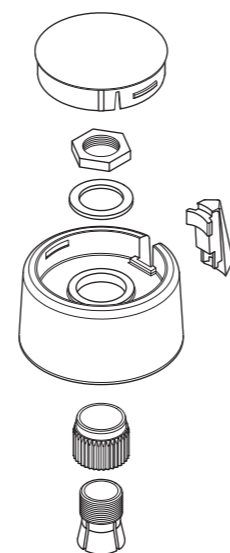

# COM-KNOBS

**YOUR ADVANTAGE**

- clip-on covers with or without a finger recess for finer control and adjustment
- also suitable for fitting accessory disks, dials, stator and nut covers
- the design is similar to our innovative TOP-KNOBS series; this guarantees you a uniform appearance when using the two knob technologies
- modern colour combinations

**APPLICATION FIELDS**

For rotary potentiometers with shaft ends corresponding to DIN 41591.

- Measuring and control technology
- Medical and wellness devices
- Laboratory equipment
- Heating and air conditioning
- Communication equipment
- Building management

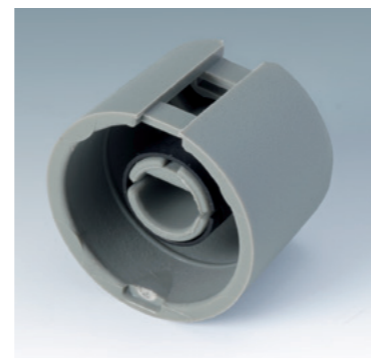
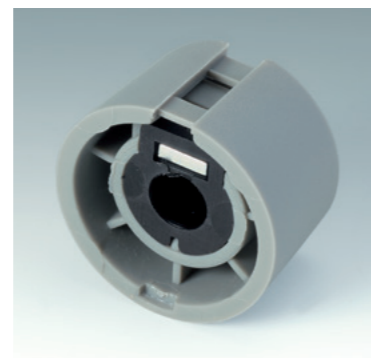

## TOP-KNOBS

### UNIQUELY MODERN TUNING KNOBS

Our TOP-KNOBS are unique in design and are thus the ideal solution for users looking for that special something. Individual marking elements define the function of the tuning knob and give your equipment a modern, contemporary appearance.

### YOUR ADVANTAGE

- aesthetically pleasing knob design – iF product design award
- lateral fixing screw for axis corresponding to DIN 41591 or for flattened ends

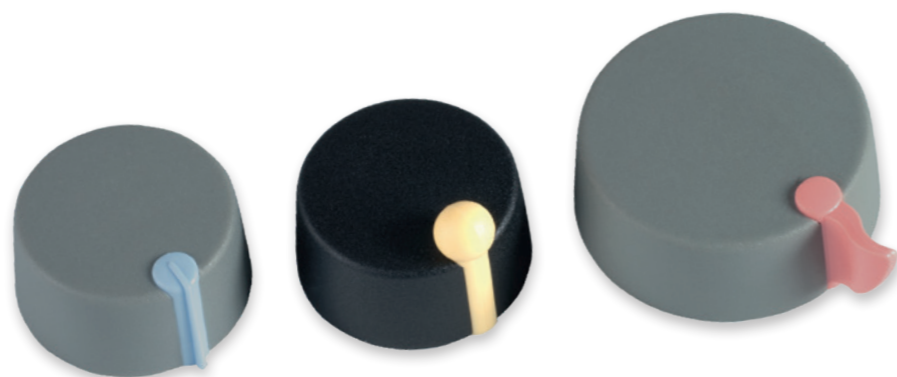

### MATERIAL / COLOUR

Knob:

- PA 6, volcano
- PA 6, nero

Marking elements

– depending on the type –

- PA 6, coral
- PA 6, beach
- PA 6, lagoon
- PA 6, sky
- PA 6, mineral

### KNOB SIZES (MM)

ø 16 mm

(boreholes 4 mm, 6 mm, 6/4,6 mm)

ø 20 / ø 24 / ø 31 und ø 40 mm

(boreholes 4 mm, 6 mm, 1/4", 6/4,6 mm)

### CUSTOMISING

- Machining
- Printing
- Laser marking
- Installation / Assembly of acc.

### FASTENING

With lateral screw fixing on shaft ends according to DIN 41591.

Pinned onto the axes with flattened shaft ends ø 6/4,6 mm.

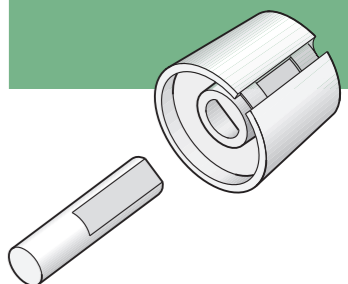

Order data see pages 22-23

## TOP-KNOBS

### YOUR ADVANTAGE

- the fixing technique rules out any possibility of contact with live parts
- recessed underside to allow for external potentiometer fixing nuts
- modern colour combinations
- individual, functional marking elements, e.g. for fine calibration, clip into the sides and hide the lateral fixing screw

### APPLICATION FIELDS

For rotary potentiometers with shaft ends corresponding to DIN 41591 or with flattened ends ø 6/4,6 mm.

- Measuring and control technology
- Medical and wellness devices
- Laboratory equipment
- Heating and air conditioning
- Communication equipment
- Building management



# COMBINATION KNOBS

## VERSATILE COLLET KNOB SYSTEM

Suitable for a huge number of applications, our COMBINATION KNOBS feature a reliable collet fixing system, and can be configured as round knobs, wing knobs and spindle-shaped knobs in combination with a large selection of accessories.

### Collet Type

- sizes 10 and 13: blind holes with screw fixing
- sizes 16 and 20: brass collet with stepped counter-bored hole, except for axes 4 mm
- from size 23 up: brass collet with through holes

## VERSIONS

- **Round Knobs:**  
sizes  $\varnothing$  9, 10, 13.5, 16, 20, 23, 31, 40, 50 mm with boreholes 3, 4, 6, 8 mm, 1/8", 1/4" (depend from the size)
- **Wing Knobs:**  
sizes  $\varnothing$  13.5, 16 mm with borehole 6 mm
- **Spindle-shaped Knobs:**  
sizes  $\varnothing$  16, 23, 31, 40 mm with boreholes 3, 4, 6 mm (depend from the size)

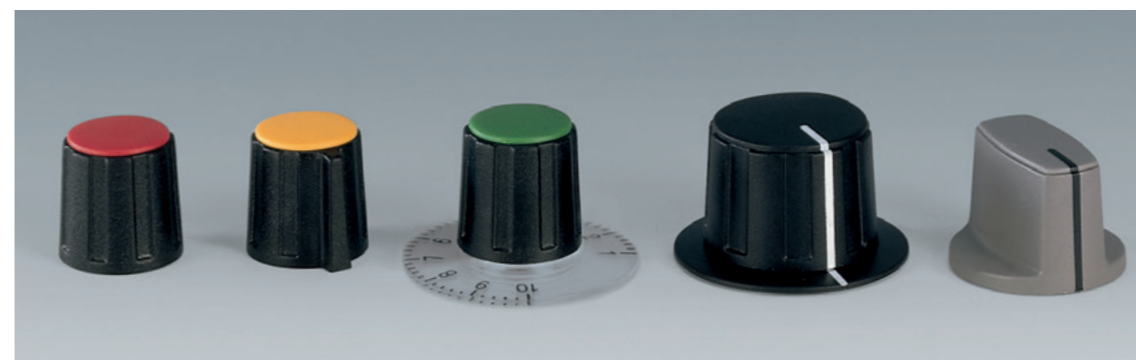

## MATERIAL / COLOUR

- Knob:
- ABS (UL 94 HB), dusty grey (RAL 7037)
  - ABS (UL 94 HB), black (RAL 9005)
- Cover\*:
- ABS (UL 94 HB), red, yellow, green, light blue, pebble grey, dusty grey
- Arrow disk\*:
- ABS (UL 94 HB), black, red, dusty grey
- Disk\*:
- ABS, black (RAL 9005)
- Dial\*:
- PC (UL 94 HB)
- Nut cover\*:
- ABS, black (RAL 9005)
  - ABS, dusty grey (RAL 7037)
- \*depending on the type / size

## KNOB SIZES (MM)

- $\varnothing$  9 mm /  $\varnothing$  10 mm /  $\varnothing$  13.5 mm
- $\varnothing$  16 mm /  $\varnothing$  20 mm /  $\varnothing$  23 mm
- $\varnothing$  31 mm /  $\varnothing$  40 and  $\varnothing$  50 mm

## FASTENING

With collet fixture system for rotary potentiometer with shaft ends according to DIN 41591.

Sizes 10 and 13 have blind holes and screw fixing. From knob size 23 up through holes ① (sizes 16 + 20 stepped ②, except for axes 4 mm).



## CUSTOMISING

- Machining
- Printing
- Laser marking
- Lacquering

# COMBINATION KNOBS

## YOUR ADVANTAGE

- standard round, wing and spindle type design with matt surfaces
- secure operation by tried and tested collet fixing system
- convenient assembly of knobs from the front; brass collet fixing system for tight fitting to the control spindle
- clip-on covers in different colours, with or without indicator line
- also suitable for fitting accessory arrow disks, disks, dials, stator and nut covers

## APPLICATION FIELDS

- For rotary potentiometers with shaft ends corresponding to DIN 41591. Also suitable for profiled axes 6/4.6 mm in combination with the torsion protection (accessory).
- Medical, wellness devices and laboratory equipment
  - Measuring and control technology
  - Heating and air conditioning
  - Communication equipment





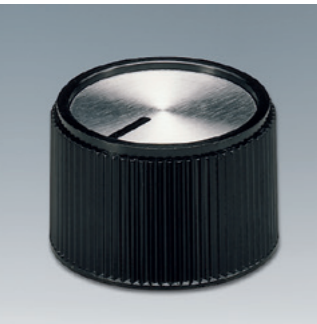
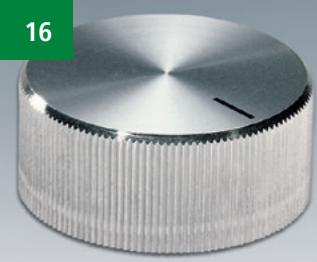

**MATERIAL / COLOUR**

Knob

- Thermoplastic, black
- Duroplast, black

Insert embellisher / embellisher cap (depending on the type)

- Aluminium

**KNOB SIZES (MM)**

Sizes from ø 12 to ø 38 mm with spindle sizes 4 mm or 6 mm.

**FASTENING**

Lateral screw fixing type A or B for rotary potentiometer with shaft ends.

**CUSTOMISING**

- Machining
- Printing
- Installation / Assembly of acc.

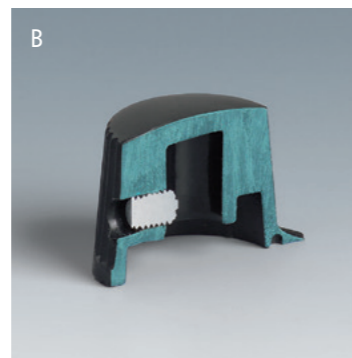
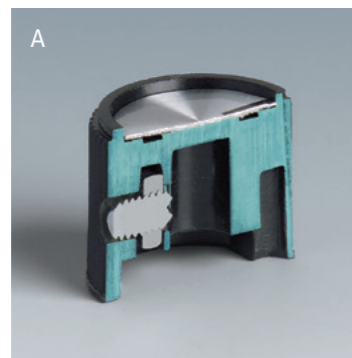
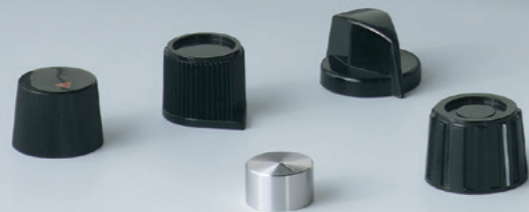

Order data see pages 32-35

# TUNING KNOBS "CLASSIC"

**PRACTICAL RANGE OF TUNING KNOBS**

Choose a knob that meets your own special size and design requirements. OKW TUNING KNOBS are suitable for many different applications and are offered in thermoplastic for normal use and thermosetting plastic (Duroplast) for high temperature resistance requirements.

**APPLICATION FIELDS**

For rotary potentiometers with shaft ends corresponding to DIN 41591: Measuring and control technology, medical and wellness devices, laboratory equipment, heating and air conditioning and communication equipment.

**YOUR ADVANTAGE**

- different designs and sizes: practical, with a good grip
- high-grade metal effect with aluminium cap or insert embellisher; the colour and styling of your front panel thus forms a unified whole
- models with markings; advantageous for adjusting and indicating
- lateral screw fixing for rotary potentiometer with shaft ends
- sizes from ø 12 to ø 38 mm with spindle sizes 4 mm or 6 mm
- accessory insert: reduces borehole from 6 to 4 mm



OPERATING ELEMENT FOR AN INTENSIVE CARE VENTILATOR



USB SDR VFO TUNING KNOB



CONTROL KNOBS FOR VIDEO MAGNIFIER



CONTROL UNIT FOR PHOTOVOLTAIC SOLAR INSTALLATIONS

# APPLICATIONS

Examples of customers show different possibilities for the use of our tuning knobs.

Please refer to our website [www.okw.com](http://www.okw.com) for further applications.



CONTROL ELEMENT FOR RESPIRATORY ASSISTANCE APPARATUS



KNOB									
NEW Knob ø	Borehole D	Torque (Nm)		Dim. in mm	Colour 'Soft Touch'	Part-No.			
		assembly	function			with optional LED illumination		without LED illumination	
36	6 mm	1.5	1.2		●	B 71 36 061	B 72 36 061	B 71 36 062	B 72 36 062
	6 mm	1.5	1.2		●	B 71 36 063	B 72 36 063	B 71 36 064	B 72 36 064
	1/4"	1.5	1.2		●	B 71 36 631	B 72 36 631	B 71 36 632	B 72 36 632
	1/4"	1.5	1.2		●	B 71 36 633	B 72 36 633	B 71 36 634	B 72 36 634
46	6 mm	1.5	1.2		●	B 71 46 061	B 72 46 061	B 71 46 062	B 72 46 062
	6 mm	1.5	1.2		●	B 71 46 063	B 72 46 063	B 71 46 064	B 72 46 064
	1/4"	1.5	1.2		●	B 71 46 631	B 72 46 631	B 71 46 632	B 72 46 632
	1/4"	1.5	1.2		●	B 71 46 633	B 72 46 633	B 71 46 634	B 72 46 634

COVER					
Cover	For knob ø	Dim. in mm		Colour	Part-No.
		a	b		
	36	26	25	●	B 75 36 109
		26	25	●	B 75 36 108
	46	36	35	●	B 75 46 109
		36	35	●	B 75 46 108

BASE				
Base	For knob ø	Application	Colour	Part-No.
46	On request, can also be used for all CONTROL-KNOBS "without illumination". Here, the base provides additional space between the knob and the operating panel for an elegant floating appearance.	●	B 75 36 208	
		●	B 75 46 209	
		●	B 75 46 208	

LED ILLUMINATION KIT			
LED illumination kit	For knob ø	Version / Application	Part-No.
46	For CONTROL-KNOBS 46 "with optional illumination". PCB D=37 mm with 12 LEDs (RGB backlight), without controller, SMD technology, connecting cable 120 mm long, 4-pin socket at the end, incl. connector. Installation in the bases available as accessories.	B 75 46 002	

OTHER ACCESSORIES						
Photo	Article	For knob ø	Version / Application	Part-No.		
						Round nut
M 7 x 0.75	13.5	A 62 07 009				
M 10 x 0.75	12.5	A 62 10 009				
	Spanner	36, 46	For tightening the round nut.	3/8" - 32G	12.5	A 62 95 009
						A 63 00 000

With optional LED illumination



Minimum components for 1 CONTROL-KNOB with optional LED illumination

- 1 knob (can be illuminated)
- 1 cover
- 1 base
- 1 LED illumination kit

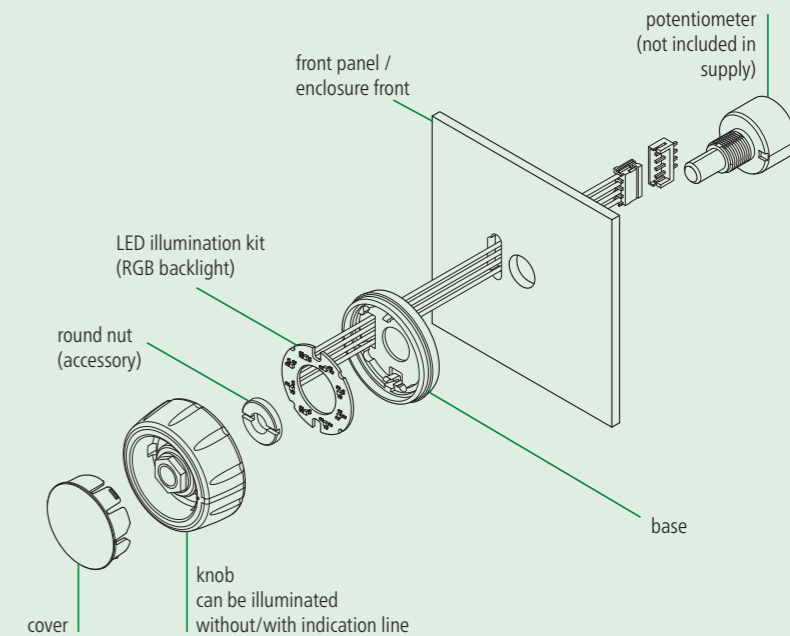

PCB with LED illumination (RGB backlight) – for power supply units with 5 V

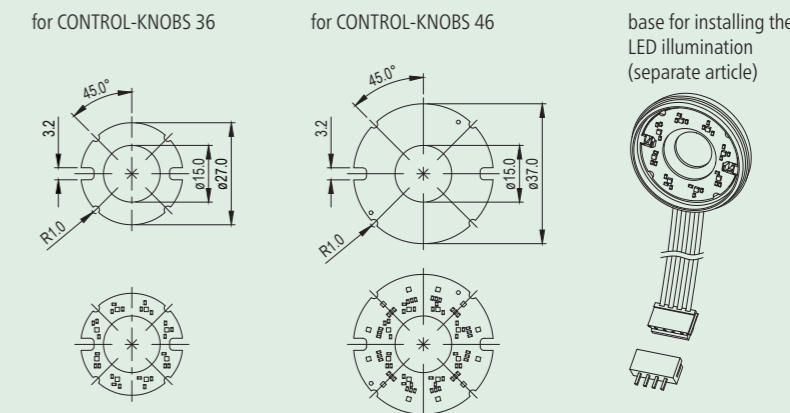

Without LED illumination



Minimum components for 1 CONTROL-KNOB without illumination

- 1 knob
- 1 cover
- the accessory base can also be added if required

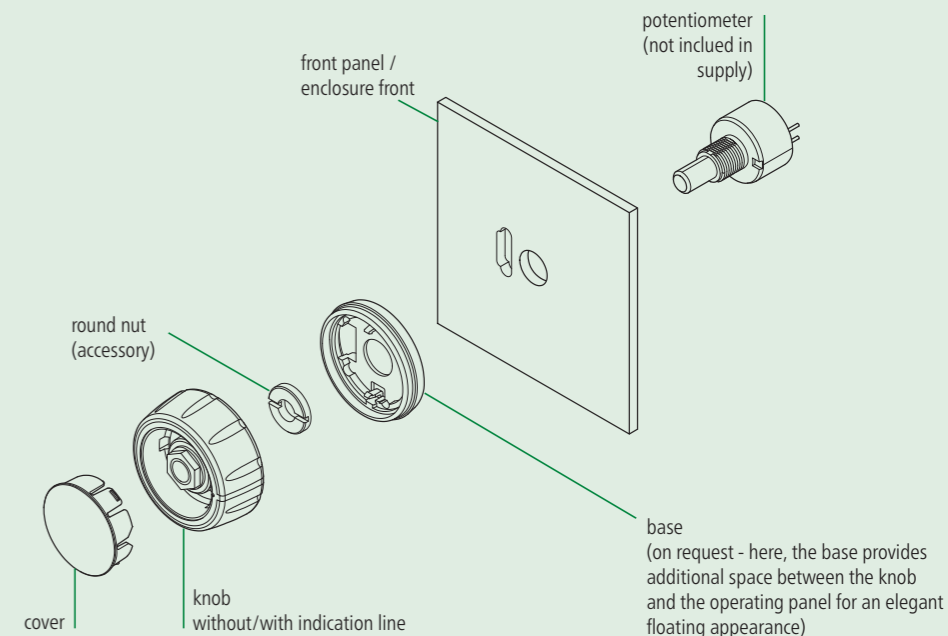



KNOB										
Knob	Knob ø	Borehole D	Torque (Nm) assembly	function	Dim. in mm	Colour	Part-No.			
							PA	PC*1	PC*1	PC*1
	33	6 mm	1.5	1.2		<ul style="list-style-type: none"> <li>volcano</li> <li>nero</li> <li>diamond</li> <li>emerald</li> <li>sapphire</li> </ul>	B 80 33 068	B 81 33 068		
							B 80 33 069	B 81 33 069		
	33	1/4"	1.5	1.2		<ul style="list-style-type: none"> <li>volcano</li> <li>nero</li> <li>diamond</li> <li>emerald</li> <li>sapphire</li> </ul>	B 80 33 638	B 81 33 638		
							B 80 33 639	B 81 33 639		
	41	6 mm	1.5	1.2		<ul style="list-style-type: none"> <li>volcano</li> <li>nero</li> <li>diamond</li> <li>emerald</li> <li>sapphire</li> </ul>	B 80 41 068	B 81 41 068		
							B 80 41 069	B 81 41 069		
	41					<ul style="list-style-type: none"> <li>volcano</li> <li>nero</li> <li>diamond</li> <li>emerald</li> <li>sapphire</li> </ul>			B 82 41 061	B 83 41 061
									B 82 41 065	B 83 41 065
	41					<ul style="list-style-type: none"> <li>volcano</li> <li>nero</li> <li>diamond</li> <li>emerald</li> <li>sapphire</li> </ul>			B 82 41 066	B 83 41 066

COVERS										
Covers	For knob ø	Dim. in mm				without finger recess	with finger recess	Colour	Part-No.	
		a	b	c	d				○	⊙
	33	29	28	9	1.7		<ul style="list-style-type: none"> <li>volcano</li> <li>nero</li> <li>diamond</li> <li>emerald</li> <li>sapphire</li> </ul>	B 86 33 008	B 86 33 108	
								B 86 33 009	B 86 33 109	
	41	37	36	11	1.7		<ul style="list-style-type: none"> <li>volcano</li> <li>nero</li> <li>diamond</li> <li>emerald</li> <li>sapphire</li> </ul>	B 86 41 008	B 86 41 108	
								B 86 41 009	B 86 41 109	

ASSEMBLY KIT				
Flush-fitting version	For knob ø	Dim. in mm (for front panel cutouts see drawings on the internet, panel thickness min. 1 mm, max. 3 mm)	Colour visible parts	Part-No.
				○
	33		<ul style="list-style-type: none"> <li>volcano</li> <li>nero</li> <li>diamond</li> <li>emerald</li> <li>sapphire</li> </ul>	B 87 33 118
				B 87 33 119
	41		<ul style="list-style-type: none"> <li>volcano</li> <li>nero</li> <li>diamond</li> <li>emerald</li> <li>sapphire</li> </ul>	B 87 41 118
				B 87 41 119

Surface-mounted version	For knob ø	Dim. in mm (for front panel cutouts see drawings on the internet, panel thickness min. 1 mm, max. 3 mm)	Colour visible parts*2	Part-No.
				○
	33		<ul style="list-style-type: none"> <li>volcano</li> <li>nero</li> <li>diamond</li> <li>emerald</li> <li>sapphire</li> </ul>	B 87 33 218
				B 87 33 219
				B 87 33 201
				B 87 33 206
	41		<ul style="list-style-type: none"> <li>volcano</li> <li>nero</li> <li>diamond</li> <li>emerald</li> <li>sapphire</li> </ul>	B 87 41 218
				B 87 41 219
				B 87 41 201
				B 87 41 206

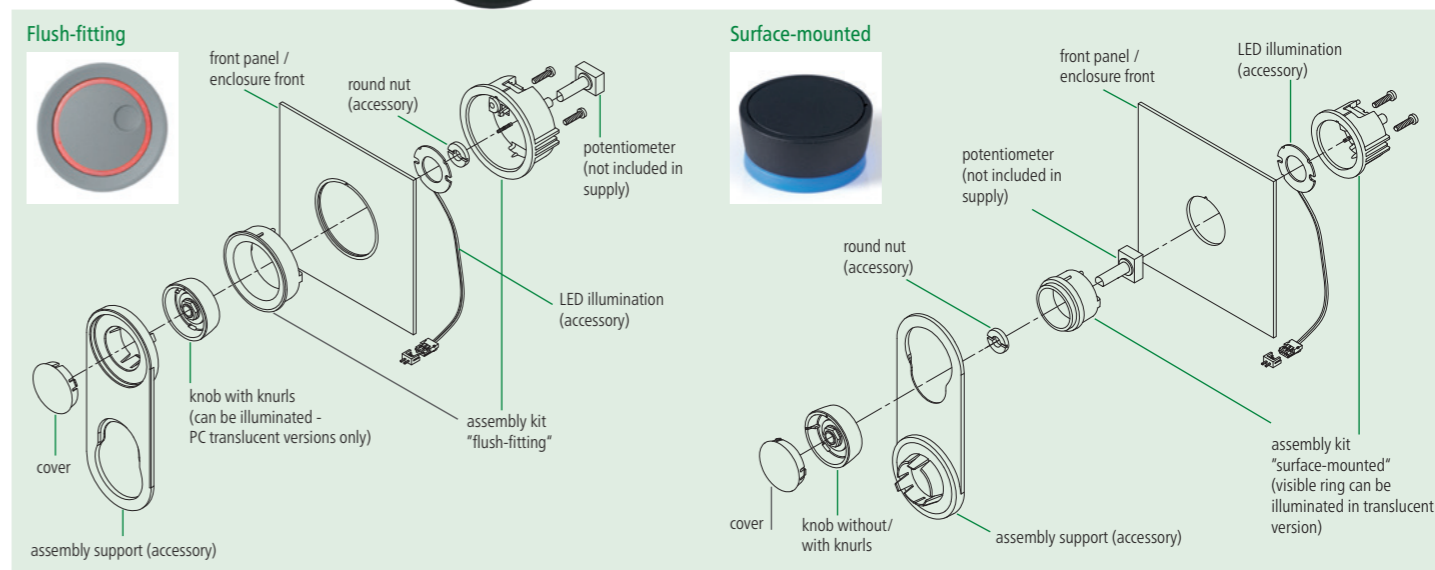
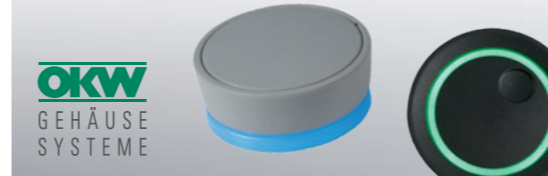

Minimum components for 1 STAR-KNOB: 1 knob, 1 cover and 1 assembly kit.

Colour STAR-KNOBS: volcano (grey), nero (black), diamond (white), emerald (green), sapphire (blue)

### STAR-KNOBS ACCESSORIES

Article	For knob ø	Version / Application	Part-No.
① LED illumination	33, 41	"white backlight", PCB with 8 LEDs, SMD-technology, 2-pin connector at the end, incl. PCB connector, for knob/assembly kit in translucent (diamond/emerald/sapphire) "RGB Backlight", PCB ø 27 mm with 8 LEDs, without controller, SMD-technology, connecting cable 120 mm long, 4-pin connector at the end, incl. PCB connector, for knob/assembly kit in translucent (diamond)	B 87 33 004 B 75 46 001
② Round nut	33, 41	for mounting of potentiometer at the assembly kit	A 62 07 009 A 62 10 009 A 62 95 009
③ Spanner	33, 41	for tightening round nuts	A 63 00 000
④ Assembly support	33	for assembly and adjusting of "flush-fitting" and "surface-mounted" versions*3	B 87 33 001
	41	for assembly and adjusting of "flush-fitting" and "surface-mounted" versions*3	B 87 41 001

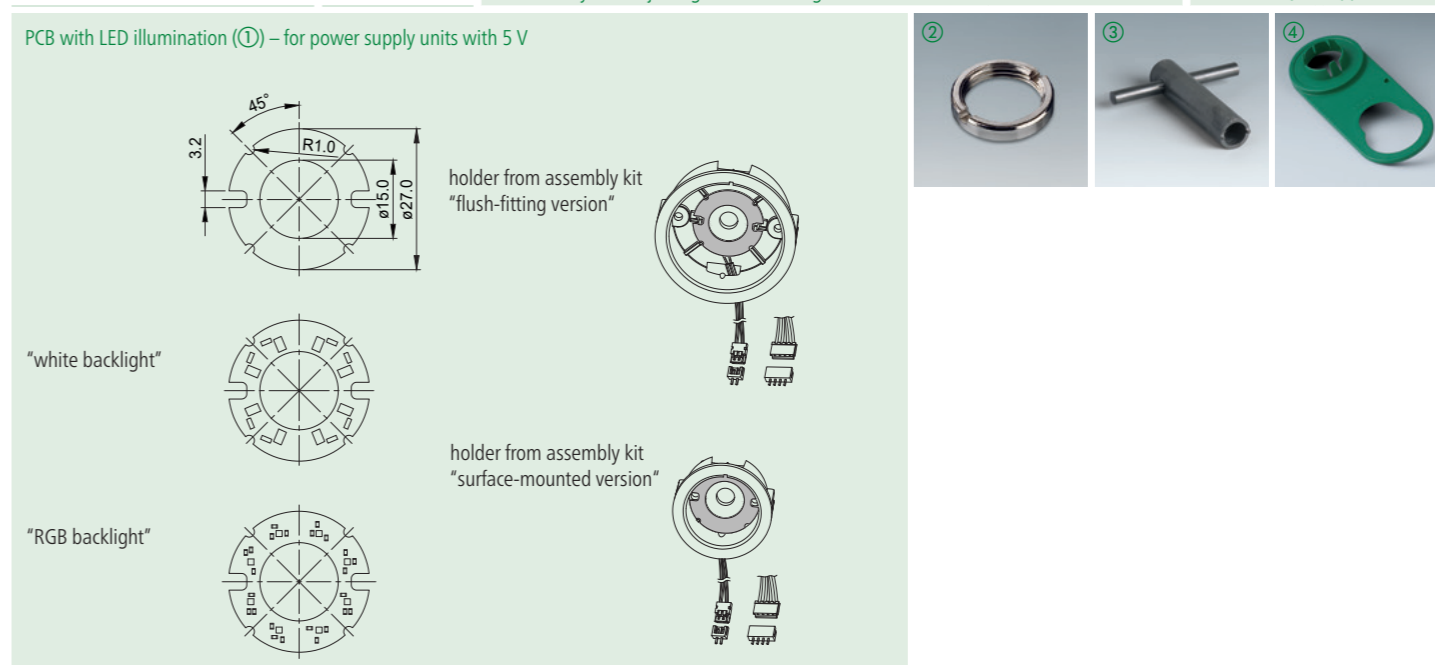

\*1 knob can be illuminated individually (flush-fitting version)

\*2 can be illuminated individually in translucent (diamond / ruby / emerald / sapphire) version (surface-mounted version)

\*3 assembly instruction see our website www.okw.com

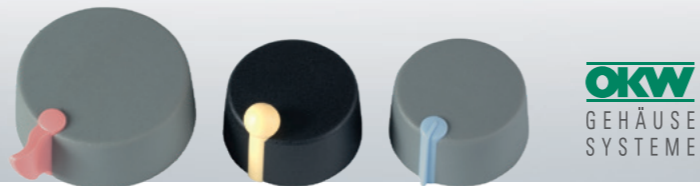

TOP-KNOB						
TOP-KNOB for "shaft end" *1	Knob ø	Dimensions in mm	Max. tightening torque	Borehole	Part-No.	
					nero	volcano
	16		0.4 Nm	4 mm	A 10 16 049	A 10 16 048
			0.4 Nm	6 mm	A 10 16 069	A 10 16 068
	20		0.5 Nm	4 mm	A 10 20 049	A 10 20 048
			0.5 Nm	6 mm	A 10 20 069	A 10 20 068
			0.5 Nm	1/4"	A 10 20 639	A 10 20 638
	24		0.5 Nm	4 mm	A 10 24 049	A 10 24 048
			0.5 Nm	6 mm	A 10 24 069	A 10 24 068
			0.5 Nm	1/4"	A 10 24 639	A 10 24 638
	31		0.6 Nm	4 mm	A 10 31 049	A 10 31 048
			0.6 Nm	6 mm	A 10 31 069	A 10 31 068
			0.6 Nm	1/4"	A 10 31 639	A 10 31 638
	40		0.65 Nm	4 mm	A 10 40 049	A 10 40 048
			0.65 Nm	6 mm	A 10 40 069	A 10 40 068
			0.65 Nm	1/4"	A 10 40 639	A 10 40 638

TOP-KNOB for "flattened end" *2	Knob ø	Dimensions in mm	Borehole	Part-No.	
				nero	volcano
	16		6/4.6 mm	A 10 16 649	A 10 16 648
			6/4.6 mm	A 10 20 649	A 10 20 648
	24		6/4.6 mm	A 10 24 649	A 10 24 648
			6/4.6 mm	A 10 31 649	A 10 31 648
	40		6/4.6 mm	A 10 40 649	A 10 40 648



\*1 lateral screw fixing with hex-socket set screw (1.5 mm) and annular cutting edge

\*2 pinned onto the axes with flattened shaft ends

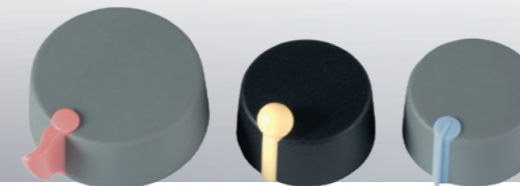

MARKING ELEMENTS						
Colour	Pin	Arrow	Globe	Disk	Wing	Part-No.
Coral	A 11 01 003	A 11 05 003				A 11 04 003
Beach	A 11 01 004	A 11 05 004	A 11 02 004	A 11 03 004		
Lagoon	A 11 01 005	A 11 05 005				
Sky	A 11 01 006	A 11 05 006				
Mineral	A 11 01 007	A 11 05 007	A 11 02 007	A 11 03 007		

Simple push-on marking elements, subsequent replacement is also possible.

### MODIFICATIONS AND FINISHING

With all conceivable technologies available in-house, we can adapt our enclosures and tuning knobs to your specific requirements.





COM-KNOBS WITH / WITHOUT RECESS					COVER				
Knob ø	Dim. in mm without recess	with recess	Borehole D	PA 6				without/ with finger recess	
16	4 mm, without chamfer		4 mm, without chamfer	A 30 16 049	A 31 16 049	A 30 16 048	A 31 16 048	a = 11.5	<ul style="list-style-type: none"> <li> A 32 16 003</li> <li> A 32 16 004</li> <li> A 32 16 005</li> <li> A 32 16 006</li> <li> A 32 16 007</li> <li> A 32 16 009</li> </ul>
	6 mm, with chamfer		6 mm, with chamfer	A 30 16 069	A 31 16 069	A 30 16 068	A 31 16 068	b = 11.0	
	1/4", with chamfer		1/4", with chamfer	A 30 16 639	A 31 16 639	A 30 16 638	A 31 16 638		
20	4 mm, without chamfer		4 mm, without chamfer	A 30 20 049	A 31 20 049	A 30 20 048	A 31 20 048	a = 14.0	<ul style="list-style-type: none"> <li> A 32 20 003</li> <li> A 32 20 004</li> <li> A 32 20 005</li> <li> A 32 20 006</li> <li> A 32 20 007</li> <li> A 32 20 009</li> </ul>
	6 mm, with chamfer		6 mm, with chamfer	A 30 20 069	A 31 20 069	A 30 20 068	A 31 20 068	b = 13.5	
	1/4", with chamfer		1/4", with chamfer	A 30 20 639	A 31 20 639	A 30 20 638	A 31 20 638		
23	4 mm, without chamfer		4 mm, without chamfer	A 30 23 049	A 31 23 049	A 30 23 048	A 31 23 048	a = 17.0	<ul style="list-style-type: none"> <li> A 32 23 003</li> <li> A 32 23 004</li> <li> A 32 23 005</li> <li> A 32 23 006</li> <li> A 32 23 007</li> <li> A 32 23 009</li> <li> A 32 23 011</li> </ul>
	6 mm, without chamfer		6 mm, without chamfer	A 30 23 069	A 31 23 069	A 30 23 068	A 31 23 068	b = 16.5	
	1/4", without chamfer		1/4", without chamfer	A 30 23 639	A 31 23 639	A 30 23 638	A 31 23 638		
31	6 mm, without chamfer		6 mm, without chamfer	A 30 31 069	A 31 31 069	A 30 31 068	A 31 31 068	a = 25.0	<ul style="list-style-type: none"> <li> A 32 31 003</li> <li> A 32 31 004</li> <li> A 32 31 005</li> <li> A 32 31 006</li> <li> A 32 31 007</li> <li> A 32 31 009</li> <li> A 32 31 011</li> </ul>
	1/4", without chamfer		1/4", without chamfer	A 30 31 639	A 31 31 639	A 30 31 638	A 31 31 638	b = 24.5	
40	6 mm, without chamfer		6 mm, without chamfer	A 30 40 069	A 31 40 069	A 30 40 068	A 31 40 068	a = 34.0	<ul style="list-style-type: none"> <li> A 32 40 003</li> <li> A 32 40 004</li> <li> A 32 40 005</li> <li> A 32 40 006</li> <li> A 32 40 007</li> <li> A 32 40 009</li> <li> A 32 40 011</li> </ul>
	8 mm, without chamfer		8 mm, without chamfer	A 30 40 089	A 31 40 089	A 30 40 088	A 31 40 088	b = 33.5	<ul style="list-style-type: none"> <li> A 32 40 103</li> <li> A 32 40 104</li> <li> A 32 40 105</li> <li> A 32 40 106</li> <li> A 32 40 107</li> <li> A 32 40 109</li> <li> A 32 40 111</li> </ul>
50	6 mm, without chamfer		6 mm, without chamfer	A 30 50 069	A 31 50 069	A 30 50 068	A 31 50 068	a = 44.0	<ul style="list-style-type: none"> <li> A 32 50 003</li> <li> A 32 50 004</li> <li> A 32 50 005</li> <li> A 32 50 006</li> <li> A 32 50 007</li> <li> A 32 50 009</li> </ul>
	8 mm, without chamfer		8 mm, without chamfer	A 30 50 089	A 31 50 089	A 30 50 088	A 31 50 088	b = 43.5	<ul style="list-style-type: none"> <li> A 32 50 103</li> <li> A 32 50 104</li> <li> A 32 50 105</li> <li> A 32 50 106</li> <li> A 32 50 107</li> <li> A 32 50 109</li> </ul>

Standard colours COM-KNOBS

- COM-KNOBS
- Nero
- Volcano
- Covers without/with finger recess
- Marking element "Peak"
- Coral
- Beach
- Lagoon
- Sky
- Mineral
- Nero
- Covers without/with finger recess
- ø 23, 31, 40 also available
- matt chromed
- Disk, Nut cover
- Black, RAL 9005
- Dust grey, RAL 7037
- Dial
- Transparent, bright surface
- with/without marking

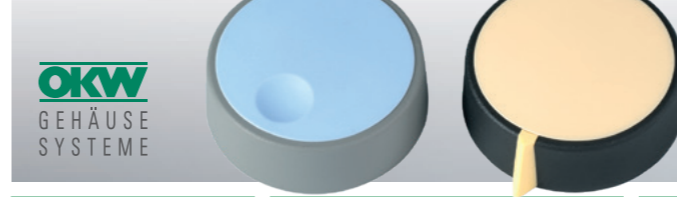

PEAK	DISK	DIAL	STATOR	NUT COVER
<p>PA 6</p> <p>only for COM-KNOBS with recess</p>	<p>ABS</p> <p>...010 = marking white</p>	<p>Polycarbonate</p> <p>...0 = symbols black</p> <p>...9 = symbols silver</p>	<p>Aluminium</p> <p>marking black</p>	<p>ABS</p> <p>...010 = marking white</p> <p>...018 = marking black</p>
<p>a = 3.9</p> <ul style="list-style-type: none"> <li> A 33 16 003</li> <li> A 33 16 004</li> <li> A 33 16 005</li> <li> A 33 16 006</li> <li> A 33 16 007</li> <li> A 33 16 009</li> </ul>	<p>a = 23.0</p> <p>b = 10.0</p> <p>c = 1.3</p>	<p>a = 31.0</p> <p>b = 14.5</p> <p>c = 10.0</p> <p>d = 2.5</p> <p>e = 1.7</p> <p>(ø 16 with moulded-on nut cover)</p>	<p>a = 16.0</p> <p>b = 10.1</p> <p>c = 15.5</p>	<p>a = 19.3</p> <p>b = 17.6</p> <p>c = 10.0</p> <p>d = 3.3</p> <p>e = 4.3</p> <p>a = 16.4</p> <p>b = 14.6</p> <p>c = 10.0</p> <p>c = 3.3</p> <p>e = 4.3</p> <p>f = 10.2</p>
<p>a = 4.0</p> <ul style="list-style-type: none"> <li> A 33 20 003</li> <li> A 33 20 004</li> <li> A 33 20 005</li> <li> A 33 20 006</li> <li> A 33 20 007</li> <li> A 33 20 009</li> </ul>	<p>a = 31.0</p> <p>b = 16.5</p> <p>c = 1.3</p>	<p>a = 36.0</p> <p>b = 12.0</p> <p>c = 1.5</p>	<p>a = 20.0</p> <p>b = 10.1</p> <p>c = 18.0</p>	
<p>a = 4.0</p> <ul style="list-style-type: none"> <li> A 33 20 003</li> <li> A 33 20 004</li> <li> A 33 20 005</li> <li> A 33 20 006</li> <li> A 33 20 007</li> <li> A 33 20 009</li> </ul>	<p>a = 40.0</p> <p>b = 16.5</p> <p>c = 1.6</p>	<p>a = 40.0</p> <p>b = 16.3</p> <p>c = 1.3</p>	<p>a = 23.0</p> <p>b = 10.2</p> <p>c = 20.0</p>	
<p>a = 4.0</p> <ul style="list-style-type: none"> <li> A 33 20 003</li> <li> A 33 20 004</li> <li> A 33 20 005</li> <li> A 33 20 006</li> <li> A 33 20 007</li> <li> A 33 20 009</li> </ul>	<p>a = 50.1</p> <p>b = 24.0</p> <p>c = 1.8</p>			
<p>a = 4.0</p> <ul style="list-style-type: none"> <li> A 33 20 003</li> <li> A 33 20 004</li> <li> A 33 20 005</li> <li> A 33 20 006</li> <li> A 33 20 007</li> <li> A 33 20 009</li> </ul>				





**OKW**  
GEHÄUSE  
SYSTEME

ROUND KNOB		SPINDLE-SHAPED KNOB				COVER	
ABS (UL 94 HB)						ABS (UL 94 HB) ...100 = indicator line white, otherwise in black	
Knob ø	Shape	Borehole D					without indicator line / with indicator line
20	<b>ROUND KNOB</b>	4 mm, without chamfer 6 mm, with chamfer 1/4", with chamfer	A 25 20 040 A 25 20 060 A 25 20 630	A 26 20 040 A 26 20 060	A 25 20 068 A 26 20 068		a = 17.5 b = 15.2 c = 5.5
							<ul style="list-style-type: none"> <li><span style="color: black;">●</span> A 41 20 000 A 41 20 100</li> <li><span style="color: red;">●</span> A 41 20 002 A 41 20 102</li> <li><span style="color: yellow;">●</span> A 41 20 104</li> <li><span style="color: green;">●</span> A 41 20 005</li> <li><span style="color: blue;">●</span> A 41 20 006 A 41 20 106</li> <li><span style="color: grey;">●</span> A 41 20 007 A 41 20 107</li> <li><span style="color: lightgrey;">●</span> A 41 20 008 A 41 20 108</li> </ul>
23	<b>ROUND KNOB</b>	4 mm, without chamfer 6 mm, without chamfer 1/4", without chamfer	A 25 23 040 A 25 23 060 A 25 23 630	A 26 23 040 A 26 23 060	A 25 23 068 A 26 23 068		a = 20.4 b = 17.4 c = 6.5
							<ul style="list-style-type: none"> <li><span style="color: black;">●</span> A 41 23 000 A 41 23 100</li> <li><span style="color: red;">●</span> A 41 23 002 A 41 23 102</li> <li><span style="color: yellow;">●</span> A 41 23 004</li> <li><span style="color: green;">●</span> A 41 23 105</li> <li><span style="color: blue;">●</span> A 41 23 006 A 41 23 106</li> <li><span style="color: grey;">●</span> A 41 23 007 A 41 23 107</li> <li><span style="color: lightgrey;">●</span> A 41 23 008 A 41 23 108</li> </ul>
	<b>SPINDLE-SHAPED KNOB</b>	4 mm, with chamfer 6 mm, with chamfer		A 24 23 040 A 24 23 060	A 24 23 068		a = 20.9 b = 1.2 c = 6.5
							<ul style="list-style-type: none"> <li><span style="color: black;">●</span> A 50 23 000 A 50 23 100</li> <li><span style="color: grey;">●</span> A 50 23 008 A 50 23 108</li> </ul>
31	<b>ROUND KNOB</b>	6 mm, without chamfer 1/4", without chamfer	A 25 31 060 A 25 31 630	A 26 31 060	A 25 31 068 A 26 31 068		a = 28.4 b = 26.0 c = 9.0
							<ul style="list-style-type: none"> <li><span style="color: black;">●</span> A 41 31 000 A 41 31 100</li> <li><span style="color: red;">●</span> A 41 31 002 A 41 31 102</li> <li><span style="color: green;">●</span> A 41 31 005</li> <li><span style="color: blue;">●</span> A 41 31 006</li> <li><span style="color: grey;">●</span> A 41 31 007</li> <li><span style="color: lightgrey;">●</span> A 41 31 008 A 41 31 108</li> </ul>
	<b>SPINDLE-SHAPED KNOB</b>	6 mm, with chamfer		A 24 31 060	A 24 31 068		a = 29.0 b = 1.4 c = 9.5
							<ul style="list-style-type: none"> <li><span style="color: black;">●</span> A 50 31 000 A 50 31 100</li> <li><span style="color: grey;">●</span> A 50 31 008 A 50 31 108</li> </ul>



**OKW**  
GEHÄUSE  
SYSTEME

ARROW DISK	DISK	DIAL	STATOR	NUT COVER
ABS (UL 94 HB)	ABS ...010 = indicator line white	Polycarbonate ...0 = symbols black ...9 = symbols silver	Aluminium indicator line black	ABS
a = 13.0 b = 20.0 c = 12.0		a = 36.0 b = 12.0 c = 1.5	a = 20.0 b = 10.1 c = 18.0	
<ul style="list-style-type: none"> <li><span style="color: black;">●</span> A 42 20 000</li> <li><span style="color: red;">●</span> A 42 20 002</li> <li><span style="color: grey;">●</span> A 42 20 008</li> </ul>		<ul style="list-style-type: none"> <li><span style="color: black;">●</span> A 44 20 001</li> <li><span style="color: grey;">●</span> A 44 20 010</li> <li><span style="color: black;">●</span> A 44 20 060</li> </ul>	A 60 20 019	
a = 14.3 b = 23.0 c = 16.5	a = 31.0 b = 16.5 c = 1.3	a = 40.0 b = 16.3 c = 1.3	a = 23.0 b = 10.2 c = 20.0	
<ul style="list-style-type: none"> <li><span style="color: black;">●</span> A 42 23 000</li> <li><span style="color: red;">●</span> A 42 23 002</li> <li><span style="color: grey;">●</span> A 42 23 008</li> </ul>	A 73 23 010	<ul style="list-style-type: none"> <li><span style="color: black;">●</span> A 44 23 010</li> <li><span style="color: grey;">●</span> A 44 23 020</li> <li><span style="color: black;">●</span> A 44 23 039</li> <li><span style="color: grey;">●</span> A 44 23 060</li> </ul>	A 60 23 019	
a = 19.5 b = 31.0 c = 16.5	a = 40.0 b = 16.5 c = 1.6	a = 49.9 b = 16.5 c = 1.5		a = 23.3 b = 20.0 c = 13.7 d = 3.3 e = 4.3
<ul style="list-style-type: none"> <li><span style="color: black;">●</span> A 42 31 000</li> <li><span style="color: red;">●</span> A 42 31 002</li> <li><span style="color: grey;">●</span> A 42 31 008</li> </ul>	A 73 31 000 A 73 31 010	<ul style="list-style-type: none"> <li><span style="color: black;">●</span> A 44 31 010</li> <li><span style="color: grey;">●</span> A 44 31 060</li> </ul>		<ul style="list-style-type: none"> <li><span style="color: black;">●</span> A 51 23 000</li> <li><span style="color: grey;">●</span> A 51 23 008</li> </ul>
				a = 31.1 b = 28.0 c = 15.5 d = 3.3 e = 4.8
				<ul style="list-style-type: none"> <li><span style="color: black;">●</span> A 51 31 000</li> <li><span style="color: grey;">●</span> A 51 31 008</li> </ul>



**OKW**  
GEHÄUSE  
SYSTEME

ROUND KNOB		SPINDLE-SHAPED KNOB				COVER	
ABS (UL 94 HB)						ABS (UL 94 HB) ...100 = indicator line white, otherwise in black	
Knob ø	Shape	Borehole D					without indicator line / with indicator line
40	<b>ROUND KNOB</b> 	6 mm, without chamfer 8 mm, without chamfer	A 25 40 060 A 25 40 080	A 26 40 060	A 25 40 068	A 26 40 068	a = 37.4 b = 34.4 c = 12.5 ● A 41 40 000 ● A 41 40 002 ● A 41 40 007 ● A 41 40 008
	<b>SPINDLE-SHAPED KNOB</b> 	6 mm, with chamfer		A 24 40 060		A 24 40 068	a = 37.9 b = 1.6 c = 13.0 ● A 50 40 000 ● A 50 40 008
50	<b>ROUND KNOB</b> 	6 mm, without chamfer	A 25 50 060	A 26 50 060	A 25 50 068		a = 47.4 b = 44.4 c = 14.5 ● A 41 50 000 ● A 41 50 008

ARROW DISK	DISK	NUT COVER
ABS (UL 94 HB)	ABS ...010 = indicator line white	ABS
a = 24.5 b = 40.0 c = 25.0	a = 50.1 b = 24.0 c = 1.8	a = 40.3 b = 36.8 c = 20.0 d = 3.1 e = 4.6
● A 42 40 000 ● A 42 40 008	● A 73 40 010	● A 51 40 000

**Standard colours knobs**

- Combination knobs
  - Black, RAL 9005
  - Dust grey, RAL 7037
- Covers (depends on size/type)
  - Black, RAL 9005
  - Red, RAL F12/0-10
  - Yellow, RAL F12/0-1
  - Green, RAL F12/0-43
  - Blue, RAL 5012
  - Pebble grey, RAL 7032
  - Dust grey, RAL 7037
- Arrow disk
  - Black, RAL 9005
  - Red, RAL F12/0-10
  - Dust grey, RAL 7037
- Dial
  - Black, RAL 9005
- Dial
  - Transparent, bright surface with/without symbols
- Nut cover (depends on size/type)
  - Black, RAL 9005
  - Dust grey, RAL 7037

ACCESSORIES FOR ROUND KNOBS / WING KNOBS AND SPINDLE-SHAPED KNOBS / COM-KNOBS			
Article	Version / Application	Dim. in mm	Part-No.
	Adjusting key For correct adjusting of combination knobs (round knobs) with indicator line, dial and arrow disk. Knob mounting without difficulties.		Round knobs ø D1 D2 D3 10 13.5 16 A 64 02 005 20 23 31 A 64 03 005
	Round nut For mounting of potentiometer at front panels. It fits under knob and nut cover (round knobs / wing knobs / spindle-shaped knobs / COM-KNOBS ø 10 / 13.5 / 16 / 20 / 23 / 31 / 40 / 50).		G ø M7 x 0.75 13.5 A 62 07 009 M10 x 0.75 12.5 A 62 10 009 3/8" - 32G 12.5 A 62 95 009
	Spanner For tightening round nuts.		A 63 00 000
	Torsion protection For torsion-proved mounting of knobs on profiled axes 6 / 4.6 mm. Suitable for round and wing knobs sizes ø 20 to 50 with 6 mm borehole (not suitable for COM-KNOBS).		Bore 6 / 4.6 A 66 00 064

**MODIFICATIONS AND FINISHING**

With all conceivable technologies available in-house, we can adapt our enclosures and tuning knobs to your specific requirements, see pages 36-37.







## WITH INSERT EMBELLISHER PLATE/CAP AND LATERAL SCREW FIXING

Picture	Material	Dim. in mm	Part-No.																		
	Duroplast black, insert embellisher plate aluminium.	<table border="1"> <thead> <tr> <th>D</th> <th>d1</th> <th>r</th> <th>H</th> <th>h1</th> <th>h2</th> </tr> </thead> <tbody> <tr> <td>28</td> <td>6</td> <td>10.5</td> <td>16</td> <td>3.5</td> <td>13</td> </tr> </tbody> </table>	D	d1	r	H	h1	h2	28	6	10.5	16	3.5	13	A 13 28 160						
D	d1	r	H	h1	h2																
28	6	10.5	16	3.5	13																
	Duroplast black, insert embellisher plate aluminium.	<table border="1"> <thead> <tr> <th>D</th> <th>d1</th> <th>r</th> <th>H</th> <th>h1</th> <th>h2</th> </tr> </thead> <tbody> <tr> <td>20</td> <td>6</td> <td>5.3</td> <td>16</td> <td>3.5</td> <td>13</td> </tr> <tr> <td>24.3</td> <td>6</td> <td>9.5</td> <td>16</td> <td>3.5</td> <td>13.2</td> </tr> </tbody> </table>	D	d1	r	H	h1	h2	20	6	5.3	16	3.5	13	24.3	6	9.5	16	3.5	13.2	A 13 20 260 A 13 24 260
D	d1	r	H	h1	h2																
20	6	5.3	16	3.5	13																
24.3	6	9.5	16	3.5	13.2																
	Duroplast black, marking element white, insert embellisher plate aluminium.	<table border="1"> <thead> <tr> <th>D</th> <th>d1</th> <th>r</th> <th>H</th> <th>h1</th> <th>h2</th> <th>l</th> </tr> </thead> <tbody> <tr> <td>23.9</td> <td>6</td> <td>8.2</td> <td>16</td> <td>3.5</td> <td>13</td> <td>18</td> </tr> </tbody> </table>	D	d1	r	H	h1	h2	l	23.9	6	8.2	16	3.5	13	18	A 13 18 560				
D	d1	r	H	h1	h2	l															
23.9	6	8.2	16	3.5	13	18															
	Duroplast black, embellisher cap aluminium.	<table border="1"> <thead> <tr> <th>D</th> <th>d</th> <th>H</th> <th>h</th> </tr> </thead> <tbody> <tr> <td>21</td> <td>6</td> <td>10</td> <td>8</td> </tr> </tbody> </table>	D	d	H	h	21	6	10	8	A 13 21 260										
D	d	H	h																		
21	6	10	8																		
	Thermoplastic black, embellisher cap aluminium.	<table border="1"> <thead> <tr> <th>D</th> <th>d</th> <th>H</th> <th>h</th> </tr> </thead> <tbody> <tr> <td>24</td> <td>6</td> <td>12.4</td> <td>10</td> </tr> </tbody> </table>	D	d	H	h	24	6	12.4	10	A 16 24 260										
D	d	H	h																		
24	6	12.4	10																		
	Thermoplastic black, embellisher cap aluminium.	<table border="1"> <thead> <tr> <th>D</th> <th>d1</th> <th>d2</th> <th>H</th> <th>h1</th> <th>h2</th> </tr> </thead> <tbody> <tr> <td>18.2</td> <td>6</td> <td>15</td> <td>14.2</td> <td>2</td> <td>12.4</td> </tr> </tbody> </table>	D	d1	d2	H	h1	h2	18.2	6	15	14.2	2	12.4	A 13 18 260						
D	d1	d2	H	h1	h2																
18.2	6	15	14.2	2	12.4																
	Duroplast black, embellisher cap aluminium.	<table border="1"> <thead> <tr> <th>D</th> <th>d1</th> <th>d2</th> <th>H</th> <th>h1</th> <th>h2</th> </tr> </thead> <tbody> <tr> <td>14.1</td> <td>4</td> <td>11.4</td> <td>14</td> <td>2</td> <td>12</td> </tr> </tbody> </table>	D	d1	d2	H	h1	h2	14.1	4	11.4	14	2	12	A 13 14 240						
D	d1	d2	H	h1	h2																
14.1	4	11.4	14	2	12																

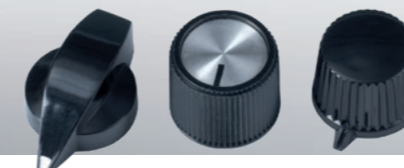

## WITH INSERT EMBELLISHER PLATE/CAP AND LATERAL SCREW FIXING

Picture	Material	Dim. in mm	Part-No.																														
	ABS (UL 94 HB), aluminium cap, indicator line black.	<table border="1"> <thead> <tr> <th>D</th> <th>d</th> <th>H</th> <th>h</th> </tr> </thead> <tbody> <tr> <td>15.9</td> <td>4</td> <td>15</td> <td>12.7</td> </tr> <tr> <td>15.9</td> <td>6</td> <td>15.2</td> <td>12.4</td> </tr> </tbody> </table>	D	d	H	h	15.9	4	15	12.7	15.9	6	15.2	12.4	A 14 16 449 A 14 16 469																		
D	d	H	h																														
15.9	4	15	12.7																														
15.9	6	15.2	12.4																														
	ABS (UL 94 HB), aluminium cap, indicator line black.	<table border="1"> <thead> <tr> <th>D</th> <th>d</th> <th>H1</th> <th>h1</th> <th>H2</th> <th>h2</th> </tr> </thead> <tbody> <tr> <td>22.1</td> <td>6</td> <td>14.3</td> <td>12</td> <td>-</td> <td>-</td> </tr> <tr> <td>22.2</td> <td>6</td> <td>-</td> <td>12</td> <td>17.9</td> <td>15.5</td> </tr> </tbody> </table>	D	d	H1	h1	H2	h2	22.1	6	14.3	12	-	-	22.2	6	-	12	17.9	15.5	A 14 21 469 A 14 22 469												
D	d	H1	h1	H2	h2																												
22.1	6	14.3	12	-	-																												
22.2	6	-	12	17.9	15.5																												
	ABS (UL 94 HB), aluminium cap, indicator line black.	<table border="1"> <thead> <tr> <th>D</th> <th>d</th> <th>H</th> <th>h</th> </tr> </thead> <tbody> <tr> <td>31.9</td> <td>6</td> <td>14</td> <td>12</td> </tr> </tbody> </table>	D	d	H	h	31.9	6	14	12	A 14 32 469																						
D	d	H	h																														
31.9	6	14	12																														
	ABS (UL 94 HB), aluminium cap, indicator line black.	<table border="1"> <thead> <tr> <th>D</th> <th>d</th> <th>H</th> <th>h</th> </tr> </thead> <tbody> <tr> <td>12</td> <td>4</td> <td>7.2</td> <td>5.5</td> </tr> <tr> <td>12</td> <td>6</td> <td>7.1</td> <td>5.6</td> </tr> </tbody> </table>	D	d	H	h	12	4	7.2	5.5	12	6	7.1	5.6	A 14 12 441 A 14 12 461																		
D	d	H	h																														
12	4	7.2	5.5																														
12	6	7.1	5.6																														
	ABS (UL 94 HB), aluminium cap, indicator line black.	<table border="1"> <thead> <tr> <th>D</th> <th>d1</th> <th>d2</th> <th>H</th> <th>h1</th> <th>h2</th> </tr> </thead> <tbody> <tr> <td>17.8</td> <td>6</td> <td>13</td> <td>12</td> <td>3.6</td> <td>10.1</td> </tr> <tr> <td>22.5</td> <td>6</td> <td>14</td> <td>13.3</td> <td>3</td> <td>11</td> </tr> <tr> <td>37.8</td> <td>6</td> <td>32.8</td> <td>15.9</td> <td>3</td> <td>13.5</td> </tr> </tbody> </table>	D	d1	d2	H	h1	h2	17.8	6	13	12	3.6	10.1	22.5	6	14	13.3	3	11	37.8	6	32.8	15.9	3	13.5	A 14 18 461 A 14 22 461 A 14 38 461						
D	d1	d2	H	h1	h2																												
17.8	6	13	12	3.6	10.1																												
22.5	6	14	13.3	3	11																												
37.8	6	32.8	15.9	3	13.5																												
	ABS (UL 94 HB), aluminium cap, indicator line black.	<table border="1"> <thead> <tr> <th>D</th> <th>d1</th> <th>d2</th> <th>H</th> <th>h1</th> <th>h2</th> </tr> </thead> <tbody> <tr> <td>18.7</td> <td>6</td> <td>12.9</td> <td>12</td> <td>3.3</td> <td>9.5</td> </tr> <tr> <td>22.7</td> <td>6</td> <td>14</td> <td>13.1</td> <td>2.9</td> <td>11.1</td> </tr> <tr> <td>32.8</td> <td>6</td> <td>15.5</td> <td>14.4</td> <td>3</td> <td>12.3</td> </tr> <tr> <td>38.9</td> <td>6</td> <td>33</td> <td>16</td> <td>3</td> <td>13.5</td> </tr> </tbody> </table>	D	d1	d2	H	h1	h2	18.7	6	12.9	12	3.3	9.5	22.7	6	14	13.1	2.9	11.1	32.8	6	15.5	14.4	3	12.3	38.9	6	33	16	3	13.5	A 14 18 261 A 14 22 261 A 14 32 261 A 14 38 261
D	d1	d2	H	h1	h2																												
18.7	6	12.9	12	3.3	9.5																												
22.7	6	14	13.1	2.9	11.1																												
32.8	6	15.5	14.4	3	12.3																												
38.9	6	33	16	3	13.5																												
	ABS (UL 94 HB), aluminium cap black anodised, indicator line white.	<table border="1"> <thead> <tr> <th>D</th> <th>d1</th> <th>d2</th> <th>H</th> <th>h1</th> <th>h2</th> </tr> </thead> <tbody> <tr> <td>18.6</td> <td>6</td> <td>13</td> <td>12</td> <td>3.3</td> <td>9.5</td> </tr> <tr> <td>22.8</td> <td>6</td> <td>14</td> <td>13</td> <td>3</td> <td>11</td> </tr> <tr> <td>33</td> <td>6</td> <td>15.5</td> <td>14.3</td> <td>3</td> <td>12.5</td> </tr> </tbody> </table>	D	d1	d2	H	h1	h2	18.6	6	13	12	3.3	9.5	22.8	6	14	13	3	11	33	6	15.5	14.3	3	12.5	A 14 18 260 A 14 22 260 A 14 32 260						
D	d1	d2	H	h1	h2																												
18.6	6	13	12	3.3	9.5																												
22.8	6	14	13	3	11																												
33	6	15.5	14.3	3	12.5																												



## WITH LATERAL SCREW FIXING

Picture	Material	Dim. in mm	Part-No.
	Duroplast black, indicator line white.	 D d1 d2 H h1 h2 18.9 6 14.9 13.5 3.1 10.8	A 13 19 260
	Thermoplastic black, red marking.	 D d1 d2 H h1 h2 16.4 4 12.5 12.3 2 10.4	A 13 16 240
	Thermoplastic black.	 D d1 d2 H h1 h2 20 6 17 16 3 14	A 13 21 160
	Thermoplastic black.	 D d H h1 h2 l 15.4 6 13.2 1.5 9.9 11.6	A 13 10 560
	Thermoplastic black.	 D d1 d2 H h1 H2 l 11.4 4 9.5 10.5 1.3 9 8.5	A 16 85 540
	Thermoplastic black.	 D d1 d2 H h1 H2 l 19.9 6 16 15.5 3.5 13.2 13.5	A 16 13 560
	Duroplast black, indicator line white.	 D d1 d2 H h1 h2 l 20 4 13.7 15.4 3.4 13.5 13.5	A 13 13 540
	Duroplast black, indicator line white.	 D d1 d2 H h1 h2 l 20 6 13.6 15.4 3.5 13.5 13.5	A 13 13 560
	Thermoplastic black, indicator line white.	 D d1 d2 H h1 h2 l 20.7 6 16.9 19.7 6.2 18.3 13.5	A 13 12 560
	Duroplast black, indicator line white.	 D d1 d2 H h1 h2 l 29 6 21 20.1 3.2 15 19	A 13 19 560
	Duroplast black, indicator line white.	 D d1 d2 H h1 h2 l 31 6 21.4 20 6.5 17.5 20	A 13 21 060

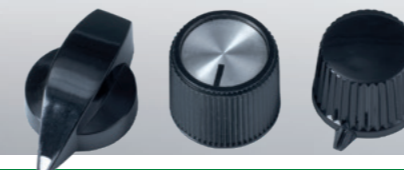

## WITH LATERAL SCREW FIXING

Picture	Material	Dim. in mm	Part-No.
	Duroplast black.	 D d1 d2 H h1 h2 l1 l2 18.8 6 16.4 12.5 2.6 10 11.5 11.5	A 13 11 860
	Duroplast black.	 D d1 d2 H h1 h2 l1 l2 20.3 6 14 18 3 14.5 19 20	A 13 19 860
	Duroplast black, indicator line white.	 D d1 d2 H h1 h2 l1 l2 20.3 6 16.7 12.8 3 11 17 15	A 13 17 860
	Duroplast black, indicator line white.	 D d1 d2 H h1 h2 l1 l2 23 6 20.2 16 3.4 14.5 21 19	A 13 21 860
	Duroplast black, indicator line white.	 D d1 d2 H h1 h2 l1 l2 25 6 21.1 20 2 14.3 24 24	A 13 24 860
<b>INSERT – for axes with shaft ends</b>			
	Thermoplastic black. For universal use in order to reduce borehole from 6 to 4 mm.	 D d1 d2 H h 7.4 4 6 7 0.6	A 13 00 040



# PRODUCT SOLUTIONS TO SATISFY YOUR SPECIAL NEEDS AND REQUIREMENTS

Look at our comprehensive standard range and select the product that best matches your design ideas, your components and the needs of your customers.

In the next step you merely have to tell us what you still need for your own very personal product. Together with you we choose the necessary modifications from our wide range of services – ideal in terms of price, quality and delivery time – to meet your specific requirements.



## MACHINING

We can perform individual machining processes for you, quickly and reliably, for sample or series production quantities. With our modern CNC machining facilities, we can produce individual solutions according to your design or a design proposed by us. We have detailed drawings of numerous enclosures and tuning knobs or 3D models for your ideas, ready to download.



## PRINTING

You can use printing on your product to give it a personal touch. It is also possible to indicate the function and usage. With precision craftsmanship, we can carry out the required printing to your satisfaction.

Depending on the printing format and type of enclosure or tuning knob, we can offer you screen printing, tampon printing as well as digital printing.



## LASER MARKING

We offer laser marking for numerous enclosures and components from our standard range.

Laser marking is ideal for individual labelling, identifying or marking. In particular, very small machine-readable markings, e.g. QR codes, barcodes, DataMatrix codes, consecutive numbering of individual parts and individual texts, can be carried out quickly and easily with laser marking.



## LACQUERING

We can lacquer the enclosures and tuning knobs in any colour you wish so that it matches your application or your company CI. For special requirements, such as for improving the feel of your product, for metallic effects or for protection from electrostatic discharge, OKW offers a wide choice of lacquers.



## INSTALLATION / ASSEMBLY

We offer you e.g. the assembly of the tuning knobs on your device, mounting of assemblies and installation of components, foils and display windows and much more.

If required we can support you in the development of the parts and components, and will help you plan suitable installation.





EASYTEC FOR MODERN SENSOR APPLICATIONS



SMART-PANEL FOR SMART-HOME, IoT AND IIoT

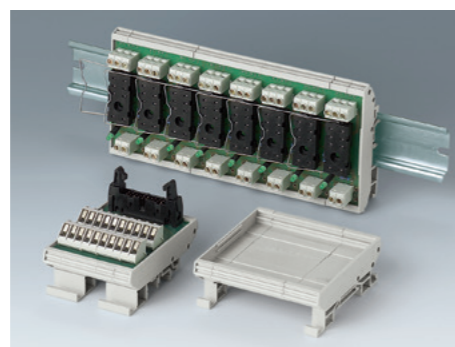

RAILTEC SUPPORT PA6 FR IN COLOUR GREY



BODY-CASE XL NEW WEARABLE ENCLOSURE SIZE



SLIM-CASE SLIM DESIGN HANDHELD ENCLOSURE, IP65

# ENCLOSURE NEWS

Do you already know our latest innovations of enclosures? Rely on innovative technology and aesthetic design from OKW for your electronics packaging too! We offer an extensive range of sustainable enclosures made of plastic and aluminum profile technology for sophisticated devices.



**ASK FOR A SAMPLE AND QUOTE**

It's quick and easy online - just go to the OKW website [www.okw.com](http://www.okw.com).

# PROPERTIES OF PLASTIC MATERIALS

Material groups	THERMOPLASTICS				DUROPLAST	
	Styrene-Polymerisate	Polycarbonate		Polyamide PA	Elastomer TPE	Phenolharz
Abbreviation & Attribute	ABS	PC		PA 6x reinforced	TPE/TPV	PF
Application for the following tuning knobs	TUNING KNOBS "CLASSIC"  COMBINATION KNOBS  Accessories COMBINATION KNOBS	STAR-KNOBS (illuminated parts)  Dials	CONTROL-KNOBS (knob body only)	TOP-KNOBS (knob body only)  COM-KNOBS (knob body only)  STAR-KNOBS (knob + assembly kit)	CONTROL-KNOBS (soft-touch outer shell)	TUNING KNOBS "LASSIC"
Properties for choice of material	Good resistance against medium temperature combined with good impact strength (only certain types) and antistatic adjustment. On the whole, good resistance against chemicals. UV-light may have a negative effect.	Thermoplastic with high temperature stability with excellent resistance to all kinds of temperature. On the whole, good resistance against chemicals and UV-light.	High light transmission over a wide wavelength range. Very good long-term heat resistance. High luminous flux stability. High mechanical stability.	Thermoplastic with high temperature stability, extremely solid and tenacious. Good sliding properties and high capacity of resistance to wear. Contact with humidity may result in a change of properties.	Weather-resistant with good chemical properties. Depending on their Shore hardness, thermoplastic elastomers can have other properties.	High thermal and chemical resistance. Insoluble and non-fusible when cured, recyclable and reusable thanks to modern processes.
Recommended use	Cases and operating elements of all kinds. Suitable for use in enclosed rooms, also at low temperatures.	Recommended for enclosures in enclosed rooms and out of doors. Not recommended for use with strong alkalis or for direct exposure to sunlight.	Ideal for LED components such as light guides, lenses, headlights for cars, street lights, in TV studios.	Ideally suited for technical parts with complex geometry, e.g. outdoor applications and machine building.	Gives tuning knobs a pleasant touch sensation. Particularly suitable for hard/soft connections with polycarbonate.	For components in chemically resistant environments.
Resistance of material to						
Gasoline	•	-	-	+	-	+
Diesel oil	+	•	•	+	-	+
Sea water	+	+	+	+	+	+
Hydrochlorid acid 10%	•	+	+	-	+	+
Weak alkaline solutions	+	-	-	-	+	+
Strong alkaline solutions	+	-	-	-	•	•
Atmospheric influences	•	+	+	+	+	+
Lactic acid	+	+	+	•	+	+
Acetone	-	-	-	+	-	•

Up-to-date material data sheets are also available in the Internet [www.okw.com](http://www.okw.com)

The plastic properties are exclusively applicable for the specified standard test pieces. Variations may occur as far as cases and technical parts are concerned.

This does not exempt you from carrying out your own tests. The application, utilisation and subsequent processing are beyond our control and the responsibility for this therefore rests solely with you.

**DESCRIPTION TO RESISTANCES OF MATERIALS**

Values at room temperature:  
+ = constant  
○ = conditionally constant  
- = inconstant

Simultaneous exposure to different media may alter the resistive properties of a material! To be safe, it is advisable to test the cases for sufficient resistance of the material under the conditions of the specific application.

**MATERIAL ABBREVIATION**

- ABS** Acrylnitrile-Butadiene-Styrene
- PA** Polyamide
- PC** Polycarbonate
- PF** Phenol-Formaldehyde Resin
- TPE** Thermoplastic Elastomer
- TPV** Thermoplastic Vulkanizate



CUSTOM MODIFICATIONS SEE PAGES 36-37

[www.okw.com](http://www.okw.com)



**OKW**  
GEHÄUSE  
SYSTEME

Odenwälder Kunststoffwerke  
Gehäusesysteme GmbH  
Friedrich-List-Str. 3  
74722 Buchen, Germany

Tel. +49 (0) 0 62 81 404-00  
EMail [Info@okw.com](mailto:Info@okw.com)  
Web [www.okw.com](http://www.okw.com)

Turtle © by OKW Gehäusesysteme, Buchen, Germany.  
Subject to technical modification without notice.  
March 2024.